

# UNIVERSAL



## QUANTUM AIR

### Powered Air Purifying Respirator

CE UK  
CA

---

Read all instructions and warnings before use. Users must understand this booklet prior to use. Keep these User Instructions for future reference. If you have questions regarding these products, just feel free to let Universal know.

---



## WARNING



### USE FOR

This product with respiratory purifies certain airborne contaminants, including dust, pollutants, fine particles as well as other contaminants, welding dust and metal dust. Gas filter option suits welders with specific working conditions. Supplying clean air to the user's facial.

### DO NOT USE FOR

- Oxygen deficient atmospheres.
- Contaminant generated in workplace and concentrations that are unknown or immediately dangerous to life or health (IDLH).
- Oxygen concentration of the air in workplace is 19.5% or lower.
- Without complete assembling of the whole product, never use, which may cause danger for human life.
- Do not use in sealed place, in place with danger as fire, explosion.
- Do not use the product with its power turned off since carbon dioxide concentration may increase and oxygen level inside the face guard may decrease.
- Do not use if the product does not supply enough air.(MIN - 165 lpm)
- Do not use at workplace with strong wind. (as negative pressure generated inside the hood, outside-air comes into the hood)

### NOTICE

If beeping alarmed, immediately get away from the contaminated area and check the device. The hose may get blocked; Battery low power; Filter is dirty and need get changed with new one.

Please EXIT that contaminated place in any cases below:

- IF some problem is shown in any part of the product, for example, the air supply is stopped or its amount is decreased.
- IF it gets hard to breathe, feeling dizzy or headache, feeling the smell or taste of the contaminants and its stimulus occurred.
- Never use in place with too high level of contamination.
- Make sure the connecting hosepipe smooth and is not entangled or is in the way of other items in the area.
- Don't remove the respirator until you are in a safe area.
- Operating temperature range between -5°C and +55°C.
- The QUANTUM AIR PAPR system is not intrinsically safe. Keep away from flammable, or explosive atmosphere.
- At very high work rates the pressure in the device may become negative at peak inhalation flow.
- Do not confuse the European standard EN12941 with other standards.

### MARKINGS ON THE EQUIPMENT

		Read the instruction before use.		Recycle
		Shall be disposed of as electronic waste.		Expiry date year/month

## DESCRIPTION & SPECIFICATION

A complete QUANTUMN AIR PAPR System includes a blower, filtration unit, breathing tube assembly, battery, and a welding helmet with auto darkening filter.

The blower assembly draws surrounding air through its filter and supplies purified air to the facial via a breathing tube. There are two levels airflow rate choice: Low speed—170+lpm; High speed—210+lpm. Switch the airflow by short press Button. Warning lights allow you to check the filter status. More warning lights turn on, more dirty it means. When warning lights flash, please replace the filter.

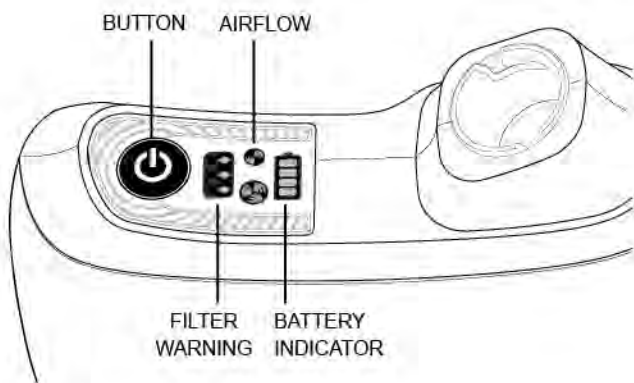

### Only Button controlling both Power On/Off and Airflow switch

#### 1. Power On/Off

On—Press and hold for 3 seconds.

Off—Press and hold for few seconds until beeping sounds finish.

#### 2. Airflow switch

Press the Button to switch between 170+lpm and 210+lpm



Indicator light refers to the airflow state. Two different levels: Low Speed—170+lpm, High Speed—210+lpm



Display screen indicates the battery capacity.



Warning lights help to check the filter status. More light spots turn on, more dirty it means. When warning lights flash, pls. replace the filter.

## RESPIRATOR SPECIFICATIONS

Airflow Rate	Manufacturer's minimum design flow rate: 165+lpm (5.8+cfm)
	Low speed: 170+lpm (6+cfm)
	High speed: 210+lpm (7.4+cfm)
	Battery type: rechargeable Li-ion battery
Fast-charging standard battery	Battery duration: 9 h -low speed (170+lpm); 5-6 h -high speed (210+lpm)
	Battery charge time: 1 hour
	Battery life: ≥ 500 charges
Filter	Filter efficiency: 99.97%
	Alarms: Visible, audible and vibrate
Temperature	Operating temperature: 23°F to 131°F (-5°C to 55°C)
	Storage temperature: 14°F to 131°F (-10°C to 55°C)
Relative Humidity (R.H.)	Operating R.H.: < 90%
	Storage R.H.: < 85%
Weight	1020g (Blower unit + fast-charging standard battery)
Respirator Approval	EN12941 TH3 — Highest level of respirator protection UKCA, UKNI

## ASSEMBLING & SPARE PARTS

The power must be turned off when replacing the filters. Install the spark screen, pre-filter, and particulate filter (gas filter if any) in filter cover.

Before installed, always make sure filter material is intact and dry with no tears or other damages. Install the filter cover assembly to the blower unit by engaging tabs on filter cover into bracket on blower unit and rotate assembly to close. Push filter cover assembly down until latch clicks into position securing filter cover assembly. Inspect both sides of cover to see that the filter cover is properly installed. To replace filter, push latch into release filter cover and replace filter as fig.1 shown.

**When to replace the filter:** If the filter gets blocked by contaminants, all the three points of warning lights will flash, accompanied with vibrate and bleeping sound. Please immediately exit contaminated environment and check the status.



fig.1

## PARTICULATE FILTER



### WARNING



- Never use the respirator without the spark screen, pre-filter, and the HE particulate filter (HEPA) installed.
- Always replace filter when damaged or blocked. Do not try to wash, clean or reuse dirty ones.
- Stored at a temperature between 14°F to 131°F (-10°C to 55°C), in a clean environment without direct light.
- Remember not confuse the markings on a filter relating to any standard other than EN 12941 with the classification of this device when used with this filter.
- Please install the particle filter according to fig.2a.

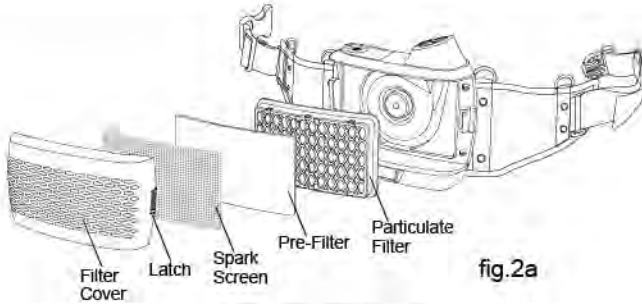

fig.2a

## GAS FILTER



### WARNING



- This gas filter must be always used together with FreFlow particle filter. The gas filter give additional protection against certain gaseous environment. (See the table below)
- The particle filter and gas filter cannot be cleaned. Stop using it immediately when smelling peculiar smell and replace it until you are in a safe area.
- Stored at a temperature between 14°F to 131°F (-10°C to 55°C), in a clean environment without direct light.
- Please install the particle filter and gas filter according to fig.2b.

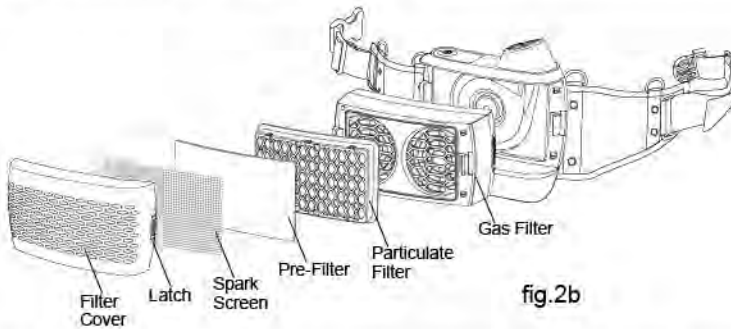

fig.2b

Marking	Part No.	Color Code	Protection Against
P (R SL)	RP154-000-033-000	White	Particulates (R=replaceable, SL=test against sodium chloride and paraffin oil)
A1B1E1K1	RP160-000-005-000	Brown / Grey / Yellow / Green	Organic gases / Inorganic gases / Sulfur dioxide, acidic gases / Ammonia and organic ammonia derivatives

## BATTERY





### WARNING



- The battery should be charged in a place that is electrically safe.
- The charging time of different types of battery is different. Actual charging time depends on the remaining battery capacity.
- Please check out the voltage of the charger (AC 110V~220V).
- Please separate the battery from the body before charging.
- Upon using-condition, the battery's life may be slightly different.

Battery is divided into fast-charging standard battery and fast-charging extended battery. When these two types of battery are used with different filter components, the battery duration is different. Please choose the appropriate battery according to actual situation. It is recommended to choose fast-charging extended battery to match the gas filter.

Description	Part No.	Picture	Description	Part No.	Picture
Fast-charging standard battery	AC420-000-005-000		Fast-charging battery charger	AC427-000-005-000	
Fast-charging extended battery	AC436-000-005-000				

### Battery performance for different combinations of filter assembly

Battery type	Battery charge time	Filter type	Airflow rate	Battery duration
Fast-charging standard battery	1 h	Particle filter	170+lpm	9 h
			210+lpm	5 - 6 h
		Particle filter + Gas filter	170+lpm	Not recommended
			210+lpm	
Fast-charging extended battery	2 h	Particle filter	170+lpm	15 h
			210+lpm	9 h
		Particle filter + Gas filter	170+lpm	11 h
			210+lpm	7.5 h

## Disassembling the battery

Push the button, take the battery out as fig.3a / 3b / 3c shown direction. Separate it from the body.

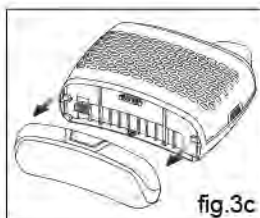
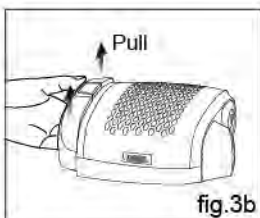
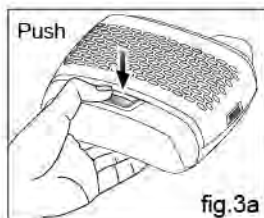

## Assembling the battery

Fitting the battery to the blower body, push until hearing 'Click' sound. (see fig.4a / 4b)

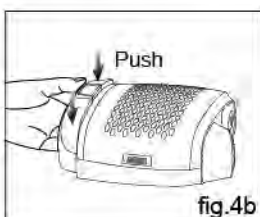
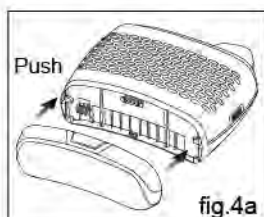

## Battery-charging

This indicator shows the battery capacity.

When four sections show up, the battery is fully charged.

When just one section left (See fig.5a), beeping sounds on, accompanied by vibration to remind users to stop work and get battery charged. The frequency is beeping sounds occur every 30 seconds and vibration occurs every 2 minutes. After the warnings occur around 15 minutes, the battery indicator gets flashing, which shows there should be at most 15 minutes left before the blower off (Airflow low speed 170+lpm).

Remove battery pack from blower assembly. Connect charger cord to battery terminal (See fig.5b).

When the indicator light on charger turns from red to green (See fig.5c), never stop it immediately and please keep charging for another 0.5h.

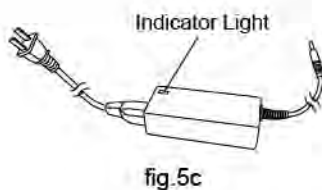
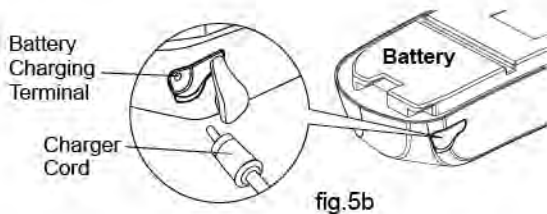

## Notice of battery use

- Do not put PAPR unit with power-on in the package. It's better to remove the battery from the body when put in the package.
- Do not keep PAPR unit inside the car in hot summer season.
- Do not throw or give the high impact to PAPR unit.
- Do not put PAPR unit on the electric heat generating equipment.
- Do not use any other battery charger.
- Battery storage temperature: 14°F to 115°F (-10°C - 45°C), R.H.< 85%.

## BREATHING TUBE



### WARNING



- Always inspect the PAPR end of the breathing tube to confirm the rubber O-ring is in place, see fig.7a. Replace if missing or damaged.
- Be sure tube is properly installed and non-filtered air cannot enter the facial.

## Assembling

Insert the two prongs on the breathing tube into the blower unit and helmet air duct (See fig.6), twist 1/4 to the anti- "open" direction (See fig.7a / 7c), then clip the breathing tube into holder on the back cover of the headgear to lock into place (See fig.8).

## Disassembling

Twist 1/4 to the "open" direction and then take the prongs out from the blower unit and helmet air duct (See fig.7b / 7d).



fig.6

### Assembling from blower

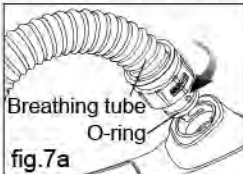

Breathing tube  
O-ring  
fig.7a

### Disassembling from blower

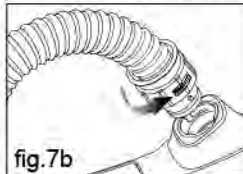

fig.7b

### Assembling from helmet

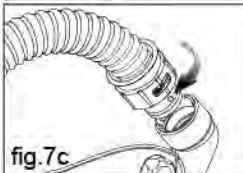

fig.7c

### Disassembling from helmet

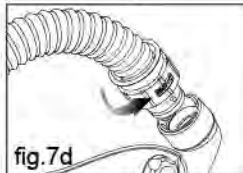

fig.7d

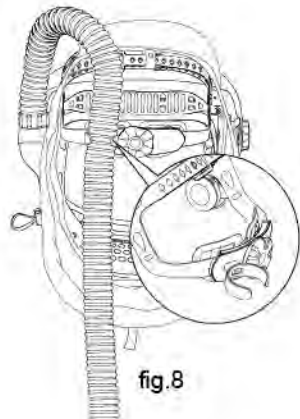

fig.8



## SHOULDER STRAP & BELT CUSHION

Connect hooks to belt (See fig.9a).

Connect with the blower by screw locking (See fig.9b).

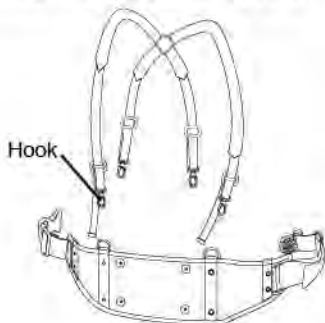

fig.9a

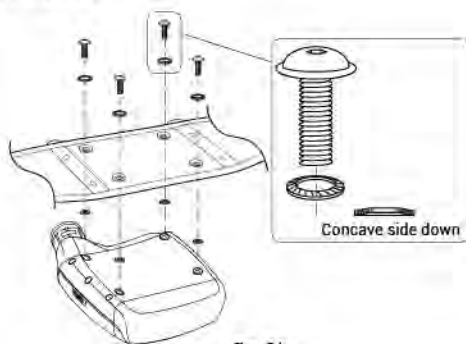

fig.9b

## AIR FLOW CONTROL

Two indicator lights on display (See fig.10a). Low Speed-170+lpm; High Speed-210+lpm.

When turn on the PAPR, default setting is low speed airflow; Switch the airflow by short press the Button (See fig.10b).

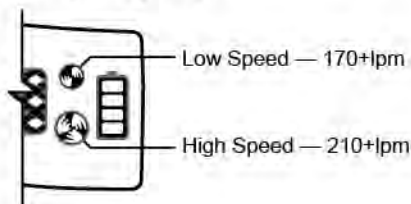

fig.10a



fig.10b

## ENTER AND EXIT CONTAMINATED AREA

**Before using respirator - Check the following items.**

**1. Blower Assembly**

Make sure the spark screen, pre-filter and particulate filter (gas filter if any) are properly installed and securely latched.

**2. Breathing Tube**

Make sure tube is not damaged and connected locked to the blower unit and helmet.

**3. Battery**

Check connection to blower unit is secure and battery is fully charged.

**4. Airflow rate test / Alarm sound check**

It's necessary to do both airflow rate test and alarm sound check before use. Testing method refers to page 9.

**5. Face seal**

Inspect face seal for damage and replace if necessary. Make sure the air is supplied to helmet.

## Always exit the contaminated area immediately if any of the following conditions occur:

- IF some problem is shown in any part of the product, for example, the air supply is stopped or its amount is decreased;
- IF it gets hard to breathe, feeling dizzy or headache, feeling the smell or taste of the contaminants and its stimulus occurred;
- NEVER use in place with too high level of contamination. If you suspect the levels reach a level which this respirator may no longer provide enough protection.

## Respirator removal

	<b>WARNING</b>	
<ul style="list-style-type: none"><li>• Never remove the respirator in areas where the air is contaminated.</li><li>• Always take off the PAPR after you step out of the workplace.</li></ul>		

### Steps

- Take off helmet and disconnect tube from helmet.
- Turn off the blower by long press button.
- Release belt. Remove straps from shoulders and remove blower off of your lower back.

## SELF CHECK BEFORE EACH TIME USE

**ALL THE TESTS MUST ALWAYS BE DONE IN A SAFE ENVIRONMENT.**

### Alarm sound check

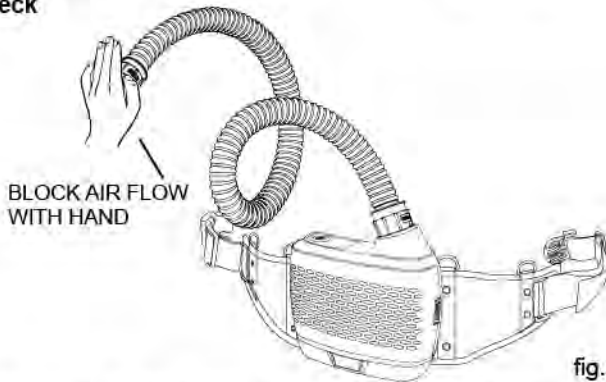

fig.11

After turning on the product, check the alarm sound warning function by blocking the air outlet as fig.11 shown in the picture above. The warning signal on the panel should flash with a sound and blower vibrate (approximately 15 to 30 seconds after the outlet is blocked). The product is working correctly if the warning functions follow the process above.

(Please make sure the filter is equipped and the battery is fully charged before doing this test.)

### Airflow rate test

**Take airflow test always before using this product.**

Make sure all the components are fully assembled before testing.

Connect the end of hose to the bottom of airflow indicator and then start the Button. Keep the Flow Indicator vertical (See fig.12).

If the ball inside the pipe floating above the limited line in low speed mode, it proves normal function.

If the ball cannot float up to limited line, please refer to Trouble-shooting Guide on page11.

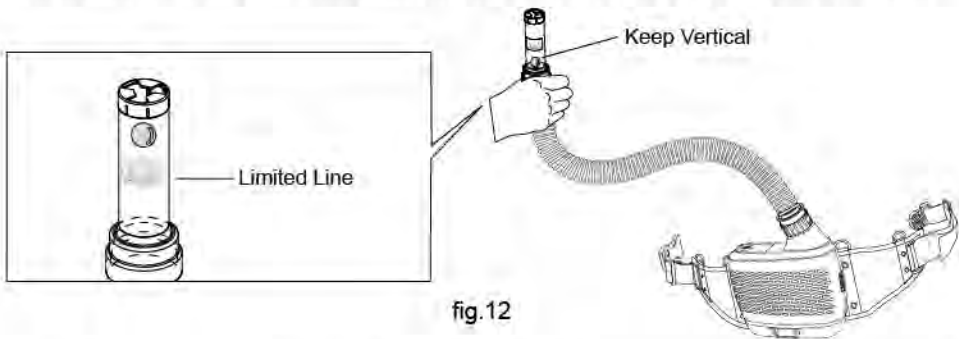

fig.12

## MAINTENANCE

The respirator components must be cleaned, inspected and prepared for next use after each use. Use soft cloth dipped in mild soap water for wiping. Be careful for the water NOT to get inside the body.

### CLEANING

1. Blower unit and battery pack: Clean the outer surfaces of the PAPR and battery pack with a soft cloth dampened in a solution of water and mild, pH neutral detergent. Be careful for the water NOT to get inside the body. Do not use solvents or abrasive cleaners. Ensure the electrical contacts of the motor/blower and battery pack are dry before assembling well.
2. Breathing tube: Wiping the exterior is insufficient. Clean the outer hose and connection on the breathing tube with the soft cloth dipped in water and detergent solution. Optional breathing tube covers can also be used to facilitate cleaning. Ensure the breathing tube is completely dry before using or storing. They cannot be immersed in liquids for cleaning and must be replaced if wet.
3. Filter: Open the filter cover and inspect all the filters and spark screens. The Particle, gas and pre-filters cannot be cleaned. The spark screen can be cleaned using a clean, soft cloth dipped in a solution of water and a mild pH neutral detergent. Completely dry the spark screen with a clean cloth. Replace the pre-filter and Particle filter if excessively dirty, wet or damaged. Do not attempt to remove contamination using a compressed air line as this will automatically invalidate the warranty. If the spark screen cannot be cleaned or is damaged, replace with a new spark screen.

The face seal can be used to facilitate cleaning after disassembling from the shell, but it must be replaced if it is damaged.

## STORAGE

The QUANTUM AIR PAPR system is not intrinsically safe. Keep away from flammable, or explosive atmosphere. Storage should be in a clean, dry, cool place with filter.

### Blower storage

Stored at a temperature between 14°F to 131°F (-10°C to 55°C), in a clean environment without direct light.

### Battery storage

To help maximize battery service life:

- Disconnect the charger after a full charge has been received.
- Battery should be removed from blower if long time storage.
- Store the battery at 14°F to 115°F (-10°C to 45°C), R.H. <85%, to get maximize battery service life.

## TROUBLE-SHOOTING GUIDE

Problems	Causes	Trouble-shooting
No airflow from blower	Blower not ON	Long press ON button.
	Battery no power	Charge the battery.
	Battery not installed properly	Check and reassemble the battery.
	Tube blocked/air leakage	Check and clear the obstruction.
Airflow test failed	The hose may get blocked/air leakage	Check the tube status.
	Dirty filter needs replacement	Replace new filter.
Battery time is too short even fully charged	Battery faulty	Replace new battery.
	Incorrect charging	Fully charge battery.
	Blocked filter	Replace filter.
	Damaged charger	Replace a new charger.
Increased sound level	Filter is getting clogged	Replace filter and pre-filter as required.
Warning indicator ON, blower vibrate and alarm sound bleeping	Tube gets blocked/air leakage	Check if tube/anywhere gets blocked before use.
	Filter assembled without removing the package	Check if the package is removed.
Feeling smell of incoming air	Damaged Filter	Check the filter status and replace new one if needed.
	Hose with leakage problem	Check how the tube assemble as well as status.
	Filter component not complete	Check and equip both filters.

# WELDING HELMET OPERATING INSTRUCTION



**WARNING**



Auto-Darkening welding helmets are designed to protect the eye and face from sparks, spatter and harmful radiation under normal welding conditions. This auto darkening filter will automatically turn on when pick it up. The filter automatically changes from a light state to a dark state when an arc is struck, and it returns to the light state when welding stops.

**The Auto-Darkening welding helmet comes assembled. But before it can be used, it must be adjusted to fit the user properly. Check battery surfaces and contacts and clean it if necessary. Verify if the battery is in good condition and installed properly. Set up for delay time, sensitivity and shade number for your application.**

**Before welding, please make sure the ADF was set to WELDING / CUTTING mode instead of GRIND mode.**

**The helmet should be stored in dry, cool and dark area and remove the battery, when not using it for a long time.**

## COMMON PROBLEMS AND REMEDIES

### • Irregular Darkening Dimming

Headband has been set unevenly and there is an uneven distance from the eyes to the filter lens. (Reset the headband to reduce the difference to the filter).

### • Auto-Darkening filter does not darken or flickers

- ① Front cover lens is soiled or damaged (Change the cover lens).
- ② Sensors are soiled (Clean the sensors surface).
- ③ Welding current is too low (Adjust the sensitivity level to higher).
- ④ Check battery and verify they are in good condition and installed properly. Also, check battery surfaces and contacts and clean if necessary.

### • Slow response

Operating temperature is too low (Do not use at temperatures below -5°C or 23°F).

### • Poor vision

- ① Front/inside cover lens and/or the filter is soiled (Change lens).
- ② There is insufficient ambient light.
- ③ Shade number is incorrectly set (Reset the shade number).
- ④ Check if removing the film on the front cover lens.

### • Welding helmet slips

Headband is not properly adjusted (Readjust the headband).



**WARNING**



The user must stop using the auto-darkening welding helmet immediately if the above-mentioned problems cannot be corrected. Contact the dealer.

## CARTRIDGE OPERATION

### • BATTERY INSTALLATION

Slide the battery holder out of the auto darkening filter, (remove the used battery when replacing battery), put new CR2450 batteries inside the battery holder, and put the battery holder back into the auto darkening filter. Please make sure the anode and cathode of the battery are installed correctly (See fig.13).



### • POWER ON / OFF

This auto darkening filter will automatically turn on when pick it up.

Sensitivity level setting 0 - 9: The welding helmet will be automatically off after 30 minutes not being used.

Sensitivity level setting =10: The filter will be darkening all the time to meet some specially welding application under both WELD MODE and CUTTING MODE. With this setting, the welding helmet will NOT automatically turn off after 30 minutes of not being used.

**To save power, remember to set the sensitivity value between 0 - 9 when not being used.**



Be sure Positive (+) side of battery faces up.

### • DIGITAL SCREEN ACTIVATION

Press any of four button to activate the digital screen (See fig.14a). After 15 seconds, digital screen will automatically turn to standby mode. Short press the button again will active the screen once more and previous settings will remain.

### • MODE CONTROL

Short Press "ON / MODE" button to select the mode appropriate for the work activity (See fig.14a):

**Weld Mode** – used for most welding applications. Push "FUNC" button to adjust shade number, sensitivity, and delay settings properly before welding. In this mode the lens turns to dark immediately when you start welding.

**Cutting Mode** – used for cutting applications. Push "FUNC" button to adjust shade number, sensitivity, and delay settings properly before cutting. In this mode the lens turns to dark immediately when you start cutting.

**Grind Mode** – used for grinding applications. In this mode the lens shade is fixed shade No. 4. Can not adjust shade number, sensitivity, and delay settings.

### • BATTERY INDICATOR

The symbol "■■■■" show the current state of the battery (See fig.14b). The volume of batteries has four levels symbol to appear (See fig.14c). The symbol "■■■■" appears on the display screen before 1-2 days of battery life remains, the CR2450 lithium batteries should be replaced in time. The symbol of the Battery Indicator is not real-time, should be updated after pressing "ON / MODE" button shortly.



fig.14a

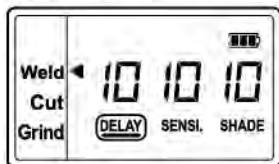

fig.14b



fig.14c

### • VARIABLE SHADE CONTROL

After turn on the lens, short press “FUNC” button to choose “SHADE”, and adjust the lens shade number. Use “▲” and “▼” buttons to select the lens shade in the dark state. The shade range for each mode are as follows:

**Cutting Mode** – Shade 5 ~ 8 (See fig.15a) **Weld Mode** – Shade 9 ~ 13 (See fig.15b)

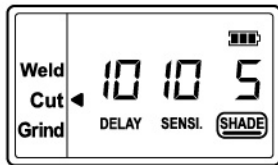

fig.15a

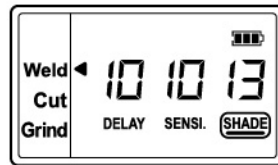

fig.15b

**Grind Mode** – No. 4 only (See fig.15c). Flip up the front-flip part for grinding job, the auto darkening filter also has grind mode setting.

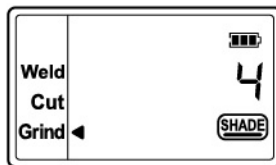

fig.15c

Select the proper shade number for your welding / cutting process, by referring to the “Shade Guide Table” on page 19.

### • SENSITIVITY CONTROL

Press “FUNC” button to choose “SENSITIVITY”. Use “▲” and “▼” buttons to make the lens more or less sensitive to arc light of different welding processes. Sensitivity setting 5-10 is the normal setting for everyday use. The sensitivity ranges for each mode are as follows:

**Cutting Mode** (Shade 5 ~ 8) / **Weld Mode** (Shade 9 ~ 13) – Sensitivity 0 ~ 10 (See fig.16a / 16b)

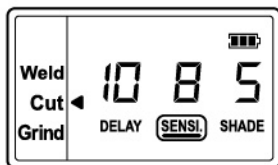

fig.16a

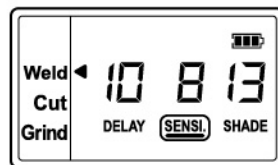

fig.16b

**Grind Mode** – No sensitivity adjustment

As a simple rule for optimum performance, it is recommended to set sensitivity to the maximum at the beginning and then gradually reduce it, until the filter reacts only to the welding light flash and without annoying spurious triggering due to ambient light conditions (direct sun, intensive artificial light, neighbouring welder's arcs etc.).

It may be necessary to adjust helmet sensitivity to accommodate different lighting conditions or if lens is flashing On and Off. Adjust helmet sensitivity as follows: Adjust helmet sensitivity in lighting conditions helmet will be used in.

• Press “▼” button to lower setting to 0.

- Face the helmet in the direction of use, exposing it to the surrounding light conditions.
- Press “▲” button repeatedly until the lens darkens, then press “▼” button until lens clears. Helmet is ready for use. Slight readjustment may be necessary for certain applications or if lens is flashing on and off.

#### • DELAY CONTROL

Press “FUNC” button to choose “DELAY”, begin lens delay adjustments. Use the Lens Delay Control “▲” and “▼” buttons to adjust the time for the lens to switch to the clear state after welding or cutting.

**Cutting Mode (Shade 5 ~ 8) / Weld Mode (Shade 9 ~ 13) – Delay 0 ~ 10 (See fig.17a / 17b)**

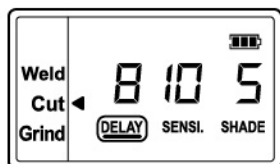

fig.17a

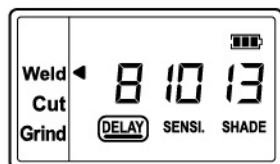

fig.17b

#### **Grind Mode – No sensitivity adjustment**

The delay is particularly useful in eliminating bright after-rays present in higher amperage applications where the molten puddle remains bright momentarily after welding. Use the Lens Delay Control buttons to adjust delay from 0 to 10 (0.1 to 1.0 second). When welding stopped, the viewing window automatically changes from dark back to light but with a pre-set delay to compensate for any bright afterglow on the workpiece. The delay time / response can be set from Level 0 to level 10. It is recommended to use a shorter delay with spot welding applications and a longer delay with applications using higher currents. Longer delays can also be used for low current TIG welding, and TIG / MIG / MAG pulse.

#### • ADJUSTING THE FIT OF THE HELMET

The overall circumference of the headband can be made larger or smaller by rotating the knob on the back of the headband (See adjustment “Y” in fig.18). This can be done while wearing the helmet and allows just the right tension to be set to keep the helmet firmly on the head without it being too tight.

- If the headband is riding too high or too low on your head, adjust the strap which passes over the top of your head. To do this release the end of the band by pushing the locking pin out of the hole in the band. Slide the two portions of the band to a greater or lesser width as required and push the locking pin through the nearest hole (See adjustment “W” in fig.18).
- Front and back bands will automatically self-adjust according to headform, and soft pads suit forehead and back of head perfectly, which will bring more comfort (See fig.19a). Test the fit of the headband by lifting up and closing down the helmet a few times while wearing it. If the headband moves while tilting, re-adjust it until it is stable.

#### • ADJUSTING THE DISTANCE BETWEEN THE HELMET AND THE FACE

Step 1: Press down and hold the “LOCK” latch on both sides (See fig.19b) and it can be slide back and forth.

Step 2: Loosen the “LOCK” latch and keep it snap into slots. Please make sure the distance between the lens to both eyes are equal, to avoid uneven darkness.



### • ADJUSTING VIEW ANGLE POSITION

Tilt adjustment is located on right side of helmet. Loosen the right headgear tension knob and adjust the lever forward or back to the proper position. Re-tighten the right headgear tension knob (See fig.19c).

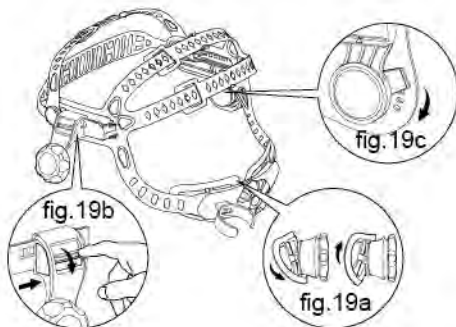
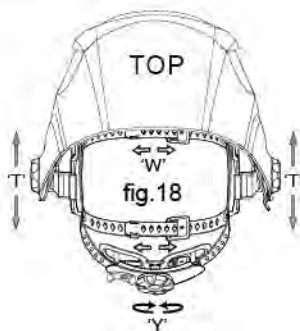

---

## MAINTENANCE

---

### REPLACING THE FRONT LENS HOLDER

Disassembling: Remove the front lens holder per fig.20a / 20b.

Assembling: Fit the one side into slot, then press and lock the other side (See fig.20c).



### REPLACING THE AUTO DARKENING FILTER

Disassembling: Press the thumb on the bottom sides of the auto darkening filter and push it upward (See fig.21a), remove the filter from the helmet shell (See fig.21b).

Assembling: First insert the auto darkening filter into the slots on left and right sides. Then push the filter down till the locks click (See fig.21c).

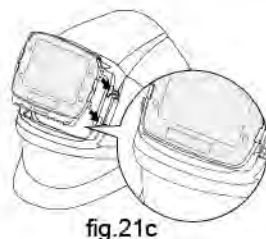
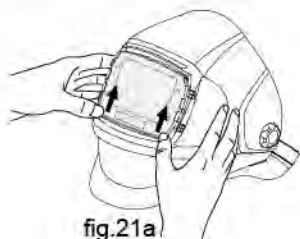

### REPLACING THE OUTSIDE COVER LENS

Replace the outside cover lens if it is damaged.

Disassembling: Remove the front lens holder per fig.20a / 20b. Place your fingernail in recess above filter view window and flex lens upwards until it releases from edges of filter view window (See fig.22a).

Assembling: Install with one side into the slot, then insert the other side.

### REPLACING THE INSIDE COVER LENS

Replace the inside cover lens if it is damaged.

Disassembling: Place your fingernail in recess above filter view window and flex lens upwards until it releases from edges of filter view window (See fig.22b).

Assembling: Assemble inside cover lens the same way as it was removed.



fig.22a



fig.22b

### REPLACING THE GRIND LENS HOLDER AND GRIND LENS

Disassembling: Remove the grind lens holder per fig.23a / 23b. Remove the grind lens per fig.23c.

Assembling: Install with one side into the slot, then insert the other side.



fig.23a



fig.23b

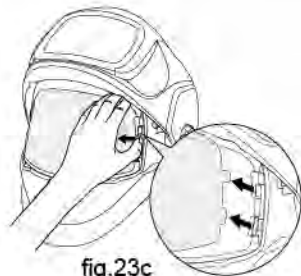

fig.23c

### REPLACING THE FACE SEAL

Press the "LOCK" key on cantilevered components and push the headgear in the direction of arrow to separate headgear from the helmet (See fig.24a). In accordance with the order of 1-4 in the figure, align the face seal with the velcro inside the helmet shell and make sure the face seal is closely attached to helmet shell (See fig.24b). Then press the "LOCK" key on cantilevered components to install the headgear to the helmet (See fig.24c), buckle up the face seal according to 1-5 points (See fig.24d).

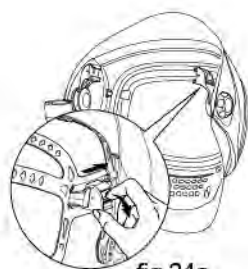

fig.24a

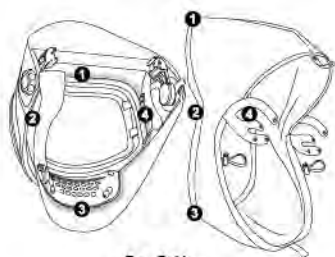

fig.24b

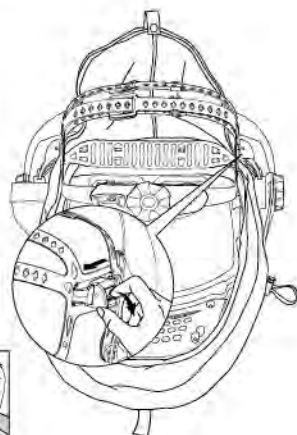
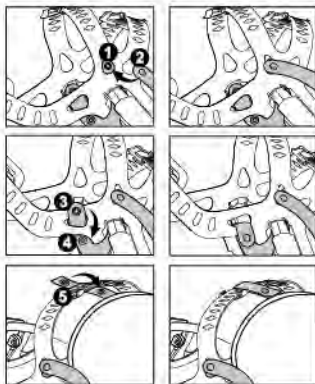

fig.24c



fig.24d



## CLEANING

Clean helmet by wiping with a soft cloth. Clean the filter surfaces regularly. Do not use strong cleaning solutions. Clean sensors and solar cells with methylated spirit and a clean cloth and wipe dry with a lint-free cloth.

## SHADE GUIDE TABLE

### GUIDE FOR SHADE NUMBERS

OPERATION	ELECTRODE SIZE 1/32 in. (mm)	ARC CURRENT (A)	MINIMUM PROTECTIVE SHADE	SUGGESTED <sup>(1)</sup> SHADE NO. (COMFORT)
Shielded metal arc welding	Less than 3 (2.5)	Less than 60	7	—
	3-5 (2.5-4)	60-160	8	10
	5-8 (4-6.4)	160-250	10	12
	More than 8 (6.4)	250-550	11	14
Gas metal arc welding and flux cored arc welding		Less than 60	7	—
		60-160	10	11
		160-250	10	12
		250-500	10	14
Gas tungsten arc welding		Less than 50	8	10
		50-150	8	12
		150-500	10	14
Air carbon Arc cutting	(Light)	Less than 500	10	12
	(Heavy)	500-1000	11	14
Plasma arc welding		Less than 20	6	6 to 8
		20-100	8	10
		100-400	10	12
		400-800	11	14
Plasma arc cutting	(Light) <sup>(2)</sup>	Less than 300	8	8
	(Medium) <sup>(2)</sup>	300-400	9	12
	(Heavy) <sup>(2)</sup>	400-800	10	14
Torch brazing		—	—	3 to 4
Torch soldering		—	—	2
Carbon arc welding		—	—	14

### PLATE THICKNESS

	in.	mm		
Gas welding				
	Light	Under 1/8	Under 3.2	4 or 5
	Medium	1/8 to 1/2	3.2 to 12.7	5 or 6
Heavy	Over 1/2	Over 12.7		6 or 8
Oxygen cutting				
	Light	Under 1	Under 25	3 or 4
	Medium	1 to 6	25 to 150	4 or 5
Heavy	Over 6	Over 150		5 or 6

<sup>(1)</sup> As a rule of thumb, start with a shade that is too dark, then go to a lighter shade which gives sufficient view of the weld zone without going below the minimum. In oxyfuel gas welding or cutting where the torch produces a high yellow light, it is desirable to use a filter lens that absorbs the yellow or sodium line the visible light of the (spectrum) operation.

<sup>(2)</sup> These values apply where the actual arc is clearly seen. Experience has shown that lighter filters may be used when the arc is hidden by the workpiece.

---

## TECHNICAL SPECIFICATIONS

---

Optical Class:	1 / 1 / 1 / 1
Viewing Area:	107 x 75 mm (4.21" x 2.95")
Cartridge Size:	156 x 123 x 33 mm (6.14" x 4.84" x 1.30")
Arc Sensor:	4
Light State:	DIN 4
Grind State:	DIN 4
Cutting Shade:	Shade No. from 5 to 8
Welding Shade:	Shade No. from 9 to 13
Shade Control:	Internal, Digital Display Control
Power On / Off:	Automatic On / Off
Sensitivity Control:	Low ~ High, Digital Display Control
UV / IR Protection:	Up to Shade DIN16 at all times
Power Supply:	Solar cell. Battery replaceable, 2 × CR2450 lithium battery
Switching Time:	1/25,000 s. from Light to Dark
Grinding:	Yes
Delay (Dark to Light):	0.1 ~ 1.0 s, Digital Display Control
Low Amperage TIG Rated:	≥ 2 amps (DC); ≥ 2 amps (AC)
Operating Temp.:	-5 °C ~ +55 °C (23 °F ~ 131 °F)
Storing Temp.:	-20 °C ~ +70 °C (-4 °F ~ 158 °F)
Helmet Material:	High Impact Resistance Nylon
ADF Weight:	192 g
Application Range:	Stick Welding (SMAW); TIG DC&AC; TIG Pulse DC; TIG Pulse AC; MIG/MAG/CO2; MIG/MAG Pulse; Plasma Arc Cutting (PAC); Plasma Arc Welding (PAW); Air Carbon Arc Cutting (CAC-A); Oxyfuel Gas Welding (OFW); Oxygen Cutting (OC); Grinding
Approved:	CE, UKCA, ANSI Z87.1, Z94.3, AS/NZS 1338.1

# PART LIST

## General Assembly

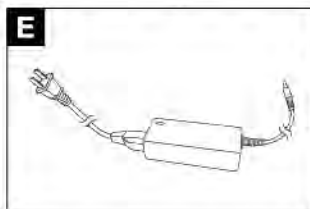
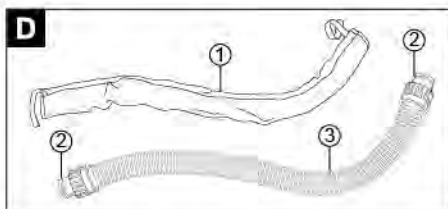
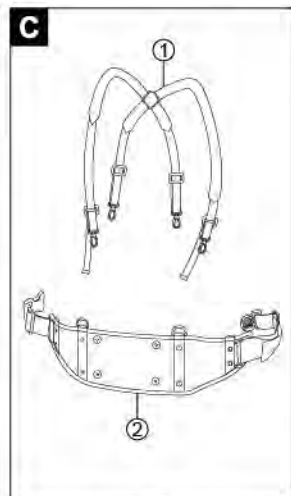
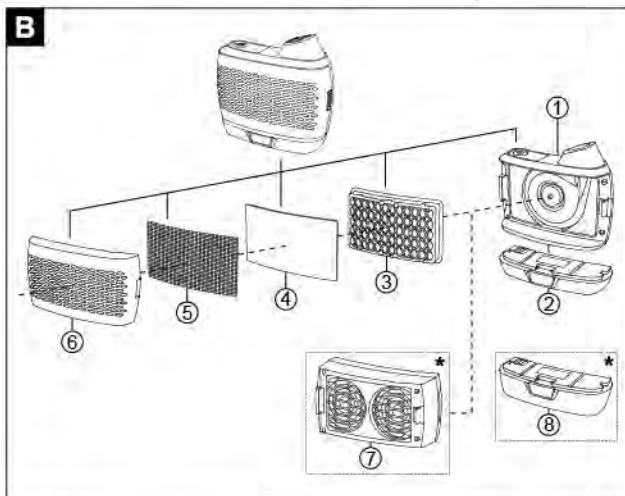
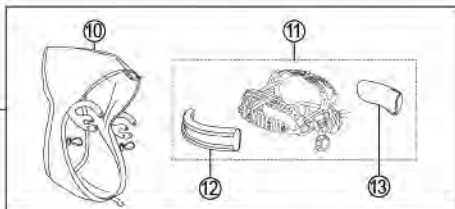
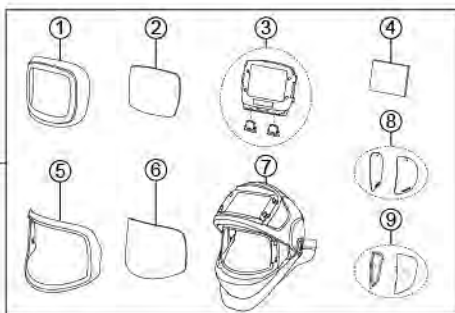
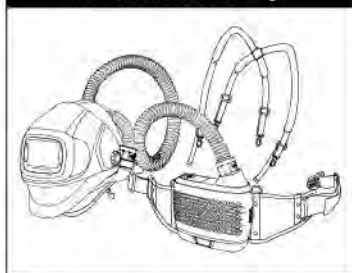

**The part with \* means it is not included in the product, which need to be purchased seperately.**

## PART LIST

ITEM	PART NO.	DESCRIPTION
<b>A. QUANTUM Helmet with Air Duct Assembly</b>		
A-1	AC429-000-005-000	Front lens holder
A-2	EP264-000-041-000	Outside cover lens (160.36×107.3 mm)
A-3	EP265-000-005-000	Auto darkening filter
A-4	EP266-000-005-000	Inside cover lens (107×80 mm)
A-5	AC430-000-005-000	Grind lens holder
A-6	EP267-000-005-000	Grind lens (anti-fog, 223×129.8 mm)
A-7	RP159-000-005-000	Helmet shell with air duct
A-8	EP269-000-005-000	Side lens cover
A-9	EP270-000-005-000	Side lens
A-10	AC435-000-005-000	Face seal
A-11	AC439-000-005-000	Headgear (Including sweatband & soft pad)
A-12	AC432-000-005-000	Sweatband
A-13	AC433-000-005-000	Soft pad
<b>B. Blower Unit</b>		
B-1	RP153-000-005-000	Body
B-2	AC420-000-005-000	Fast-charging standard battery
B-3	RP154-000-033-000	Particle filter (P3 filter)
B-4	RP155-000-033-000	Pre-filter
B-5	RP156-000-037-000	Spark screen
B-6	AC421-000-005-000	Filter cover
B-7*	RP160-000-005-000	Gas filter
B-8*	AC436-000-005-000	Fast-charging extended battery
<b>C. Wears</b>		
C-1	AC422-000-005-000	Shoulder strap
C-2	AC423-000-005-000	Belt cushion (Including screws & washers)
<b>D. Hose</b>		
D-1	AC424-000-005-000	Hose cover
D-2	AC425-000-005-000	O-ring
D-3	AC426-000-005-000	Hose (Including O-ring)
<b>E. Battery Charger</b>		
E	AC427-000-005-000	Fast-charging battery charger
<b>F. Airflow Indicator</b>		
F	AC428-000-005-000	Airflow indicator

**The part with \* means it is not included in the product, which need to be purchased seperately.**

## WARRANTY

Universal's only obligation shall be repair, replace or refund the purchase price of such parts or products material and fabrication defects free of charge within the warranty period. This warranty does not cover to cause by improper handling abuse or application other than recommended in the user instruction.

If you come across any problem during warranty period, contact your distributor, send the defective parts together with the completed defect problem if necessary.

-----

For future reference, please complete the owner's record below:

**Serial Number:**

**Purchase Date:**



EN12941:1998 +A2:2008, Class TH3 P R SL.

DIN EN175:1997

DIN EN379:2009-07

DIN EN166:2001

(EU) 2016/425

UKCA-B-210967

Approved body No: 0194

**UNIVERSAL PPE & WELDING SUPPLIES LTD**

Aqua House, Buttress Way, Smethwick, West Midlands,

England, B66 3DL

info@universalppe.co.uk

Tel: +44 (0) 121 555 7167