

UNIVERSAL 



TP SERIES

TOTAL PROTECTION

**Powered Air Purifying
Respirator**

Read all instructions and warnings before use. Users must understand this booklet prior to use. Keep these User Instructions for future reference. If you have questions regarding these products, just feel free to let Universal know.



WARNING



USE FOR

This product with respiratory purifies certain airborne contaminants, including dust, pollutants, fine particles as well as other contaminants, welding dust and metal dust. Gas filter option suits welders with specific working conditions. Supplying clean air to the user's facial.

DO NOT USE FOR

- Oxygen deficient atmospheres.
- Contaminant generated in workplace and concentrations that are unknown or immediately dangerous to life or health (IDLH).
- Oxygen concentration of the air in workplace is 19.5% or lower.
- Without complete assembling of the whole product, never use, which may cause danger for human life.
- Do not use in sealed place, in place with danger as fire, explosion.
- Do not use the product with its power turned off since carbon dioxide concentration may increase and oxygen level inside the face guard may decrease.
- Do not use if the product does not supply enough air.(MIN - 165 lpm)
- Do not use at workplace with strong wind. (as negative pressure generated inside the hood, outside-air comes into the hood)

NOTICE

If beeping alarmed, immediately get away from the contaminated area and check the device. The hose may get blocked; Battery low power; Filter is dirty and need get changed with new one.

Please EXIT that contaminated place in any cases below:

- IF some problem is shown in any part of the product, for example, the air supply is stopped or its amount is decreased.
- IF it gets hard to breathe, feeling dizzy or headache, feeling the smell or taste of the contaminants and its stimulus occurred.
- Never use in place with too high level of contamination.
- Make sure the connecting hosepipe smooth and is not entangled or is in the way of other items in the area.
- Don't remove the respirator until you are in a safe area.
- Operating temperature range between -5°C and +55°C.
- The TP SERIES PAPR system is not intrinsically safe. Keep away from flammable, or explosive atmosphere.
- At very high work rates the pressure in the device may become negative at peak inhalation flow.
- Do not confuse the European standard EN12941 with other standards.

MARKINGS ON THE EQUIPMENT

	Read the instruction before use.		Recycle
	Shall be disposed of as electronic waste.		Expiry date year/month

DESCRIPTION & SPECIFICATION

A complete TP SERIES PAPR System includes a blower, filtration unit, breathing tube assembly, battery, and a welding helmet with auto darkening filter.

The blower assembly draws surrounding air through its filter and supplies purified air to the facial via a breathing tube. There are two levels airflow rate choice: Low speed—170+lp_m; High speed—210+lp_m. Switch the airflow by short press Button. Warning lights allow you to check the filter status. More warning lights turn on, more dirty it means. When warning lights flash, please replace the filter.

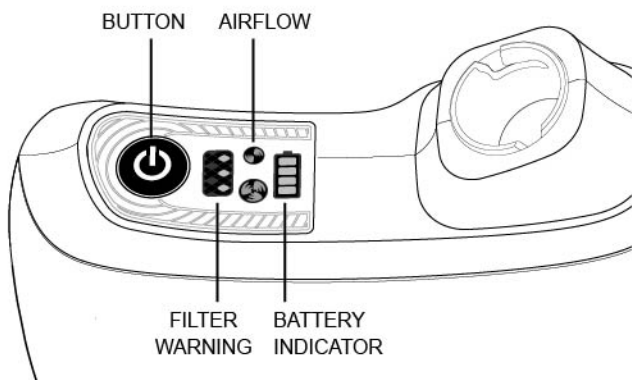

Only Button controlling both Power On/Off and Airflow switch

1. Power On/Off

On—Press and hold for 3 seconds.

Off—Press and hold for few seconds until beeping sounds finish.

2. Airflow switch

Press the Button to switch between 170+lp_m and 210+lp_m



Indicator light refers to the airflow state. Two different levels: Low Speed—170+lp_m, High Speed—210+lp_m



Display screen indicates the battery capacity.



Warning lights help to check the filter status. More light spots turn on, more dirty it means. When warning lights flash, pls. replace the filter.

RESPIRATOR SPECIFICATIONS

Airflow Rate	Manufacturer's minimum design flow rate: 165+lpm (5.8+cfm)
	Low speed: 170+lpm (6+cfm)
	High speed: 210+lpm (7.4+cfm)
	Battery type: rechargeable Li-ion battery
Fast-charging standard battery	Battery duration: 9 h - low speed (170+lpm); 5-6 h - high speed (210+lpm)
	Battery charge time: 1 hour
	Battery life: ≥ 500 charges
Filter	Filter efficiency: 99.97%
	Alarms: Visible, audible and vibrate
Temperature	Operating temperature: 23°F to 131°F (-5°C to 55°C)
	Storage temperature: 14°F to 131°F (-10°C to 55°C)
Relative Humidity (R.H.)	Operating R.H.: < 90%
	Storage R.H.: < 85%
Weight	1020g (Blower unit + fast-charging standard battery)
Respirator Approval	EN12941 TH3 — Highest level of respirator protection UKCA, UKNI

ASSEMBLING & SPARE PARTS

The power must be turned off when replacing the filters. Install the spark screen, pre-filter, and particulate filter (gas filter if any) in filter cover.

Before installed, always make sure filter material is intact and dry with no tears or other damages. Install the filter cover assembly to the blower unit by engaging tabs on filter cover into bracket on blower unit and rotate assembly to close. Push filter cover assembly down until latch clicks into position securing filter cover assembly. Inspect both sides of cover to see that the filter cover is properly installed. To replace filter, push latch into release filter cover and replace filter as fig.1 shown.

When to replace the filter: If the filter gets blocked by contaminants, all the three points of warning lights will flash, accompanied with vibrate and beeping sound. Please immediately exit contaminated environment and check the status.

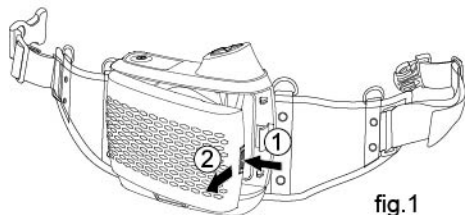

fig.1

PARTICULATE FILTER



WARNING



- Never use the respirator without the spark screen, pre-filter, and the HE particulate filter (HEPA) installed.
- Always replace filter when damaged or blocked. Do not try to wash, clean or reuse dirty ones.
- Stored at a temperature between 14°F to 131°F (-10°C to 55°C), in a clean environment without direct light.
- Remember not confuse the markings on a filter relating to any standard other than EN 12941 with the classification of this device when used with this filter.
- Please install the particle filter according to fig.2a.

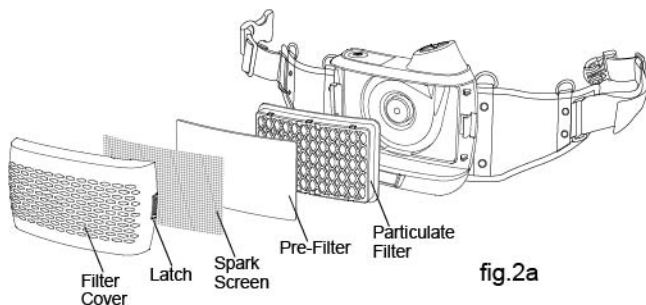

GAS FILTER



WARNING



- This gas filter must be always used together with FreFlow particle filter. The gas filter give additional protection against certain gaseous environment. (See the table below)
- The particle filter and gas filter cannot be cleaned. Stop using it immediately when smelling peculiar smell and replace it until you are in a safe area.
- Stored at a temperature between 14°F to 131°F (-10°C to 55°C), in a clean environment without direct light.
- Please install the particle filter and gas filter according to fig.2b.

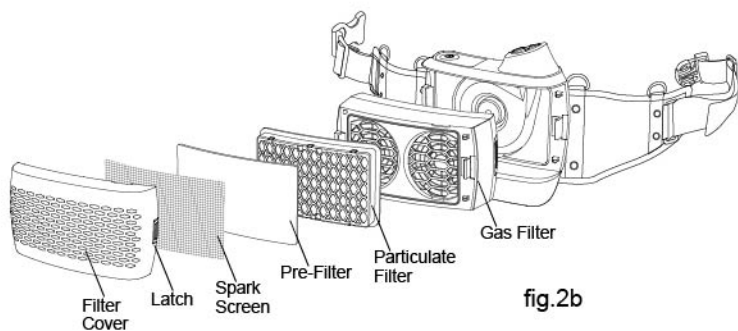

Marking	Part No.	Color Code	Protection Against
P (R SL)	RP154-000-033-000	White	Particulates (R=replaceable, SL=test against sodium chloride and paraffin oil)
A1B1E1K1	RP160-000-005-000	Brown / Grey / Yellow / Green	Organic gases / Inorganic gases / Sulfur dioxide, acidic gases / Ammonia and organic ammonia derivatives

BATTERY





WARNING



- The battery should be charged in a place that is electrically safe.
- The charging time of different types of battery is different. Actual charging time depends on the remaining battery capacity.
- Please check out the voltage of the charger (AC 110V~220V).
- Please separate the battery from the body before charging.
- Upon using-condition, the battery's life may be slightly different.

Battery is divided into fast-charging standard battery and fast-charging extended battery. When these two types of battery are used with different filter components, the battery duration is different. Please choose the appropriate battery according to actual situation. It is recommended to choose fast-charging extended battery to match the gas filter.

Description	Part No.	Picture	Description	Part No.	Picture
Fast-charging standard battery	AC420-000-005-000		Fast-charging battery charger	AC427-000-005-000	
Fast-charging extended battery	AC436-000-005-000				

Battery performance for different combinations of filter assembly

Battery type	Battery charge time	Filter type	Airflow rate	Battery duration
Fast-charging standard battery	1 h	Particle filter	170+lpm	9 h
			210+lpm	5 - 6 h
		Particle filter + Gas filter	170+lpm	Not recommended
			210+lpm	
Fast-charging extended battery	2 h	Particle filter	170+lpm	15 h
			210+lpm	9 h
		Particle filter + Gas filter	170+lpm	11 h
			210+lpm	7.5 h

Disassembling the battery

Push the button, take the battery out as fig.3a / 3b / 3c shown direction. Separate it from the body.

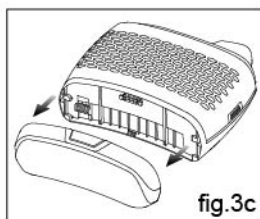
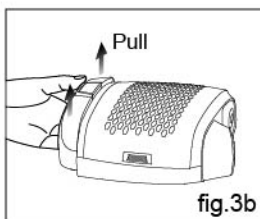
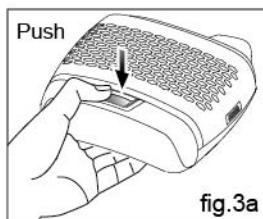

Assembling the battery

Fitting the battery to the blower body, push until hearing 'Click' sound. (see fig.4a / 4b)

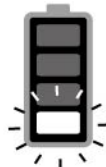
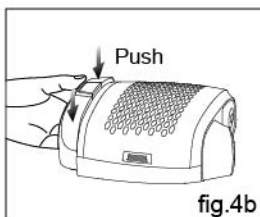
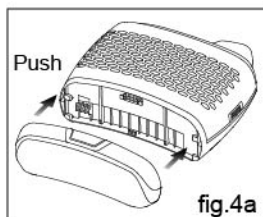

fig.5a

Battery-charging

This indicator shows the battery capacity.

When four sections show up, the battery is fully charged.

When just one section left (See fig.5a), beeping sounds on, accompanied by vibration to remind users to stop work and get battery charged. The frequency is beeping sounds occur every 30 seconds and vibration occurs every 2 minutes. After the warnings occur around 15 minutes, the battery indicator gets flashing, which shows there should be at most 15 minutes left before the blower off (Airflow low speed 170+lpm).

Remove battery pack from blower assembly. Connect charger cord to battery terminal (See fig.5b).

When the indicator light on charger turns from red to green (See fig.5c), never stop it immediately and please keep charging for another 0.5h.

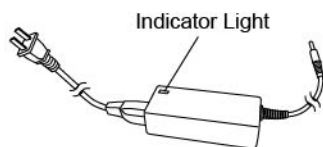
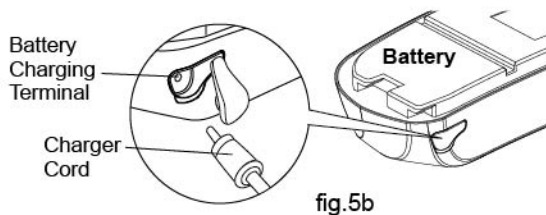

Notice of battery use

- Do not put PAPR unit with power-on in the package. It's better to remove the battery from the body when put in the package.
- Do not keep PAPR unit inside the car in hot summer season.
- Do not throw or give the high impact to PAPR unit.
- Do not put PAPR unit on the electric heat generating equipment.
- Do not use any other battery charger.
- Battery storage temperature: 14°F to 113°F (-10°C to 45°C), R.H.< 85%.

BREATHING TUBE



WARNING



- Always inspect the PAPR end of the breathing tube to confirm the rubber O-ring is in place, see fig.7a. Replace if missing or damaged.
- Be sure tube is properly installed and non-filtered air cannot enter the facial.

Assembling

Insert the two prongs on the breathing tube into the blower unit and helmet air duct (See fig.6), twist 1/4 to the anti- "open" direction (See fig.7a / 7c).

Disassembling

Twist 1/4 to the "open" direction and then take the prongs out from the blower unit and helmet air duct (See fig.7b / 7d).

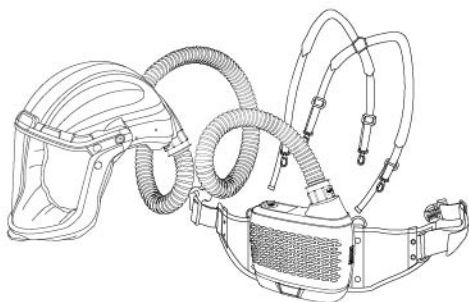

fig.6

Assembling from blower

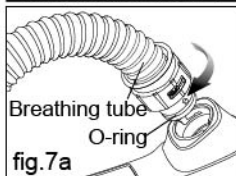

fig.7a

Disassembling from blower

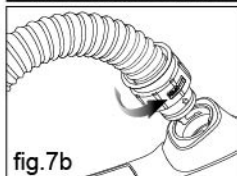

fig.7b

Assembling from helmet

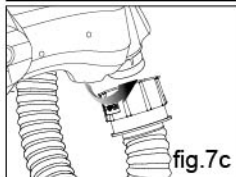

fig.7c

Disassembling from helmet

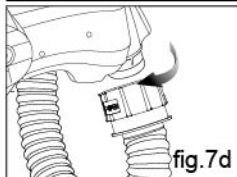

fig.7d

SHOULDER STRAP & BELT CUSHION

Connect hooks to belt (See fig.8a).

Connect with the blower by screw locking (See fig.8b).



fig.8a

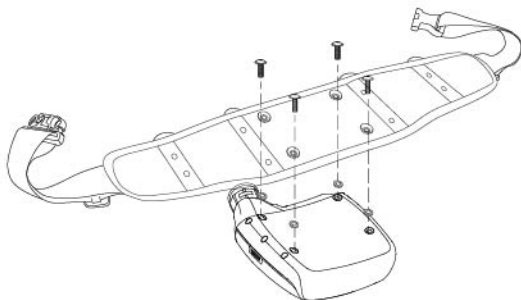

fig.8b

AIR FLOW CONTROL

Two indicator lights on display (See fig.9a). Low Speed-170+lpm; High Speed-210+lpm. When turn on the PAPR, default setting is low speed airflow; Switch the airflow by short press the Button (See fig.9b).

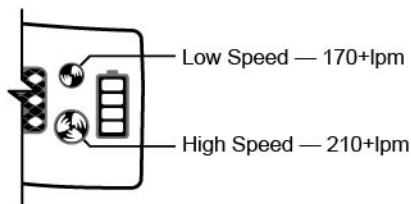

fig.9a

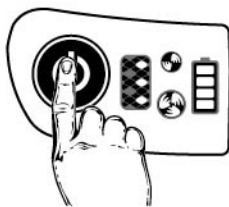

fig.9b

ENTER AND EXIT CONTAMINATED AREA

Before using respirator - Check the following items.

1. Blower Assembly
Make sure the spark screen, pre-filter and particulate filter (gas filter if any) are properly installed and securely latched.
2. Breathing Tube
Make sure tube is not damaged and connected locked to the blower unit and helmet.
3. Battery
Check connection to blower unit is secure and battery is fully charged.
4. Airflow rate test / Alarm sound check
It's necessary to do both airflow rate test and alarm sound check before use. Testing method refers to page 9.
5. Face seal
Inspect face seal for damage and replace if necessary. Make sure the air is supplied to helmet.

Always exit the contaminated area immediately if any of the following conditions occur:

- IF some problem is shown in any part of the product, for example, the air supply is stopped or its amount is decreased;
- IF it gets hard to breathe, feeling dizzy or headache, feeling the smell or taste of the contaminants and its stimulus occurred;
- NEVER use in place with too high level of contamination. If you suspect the levels reach a level which this respirator may no longer provide enough protection.

Respirator removal



WARNING



- Never remove the respirator in areas where the air is contaminated.
- Always take off the PAPR after you step out of the workplace.

Steps

- Take off helmet and disconnect tube from helmet.
- Turn off the blower by long press button.
- Release belt. Remove straps from shoulders and remove blower off of your lower back.

SELF CHECK BEFORE EACH TIME USE

ALL THE TESTS MUST ALWAYS BE DONE IN A SAFE ENVIRONMENT.

Alarm sound check

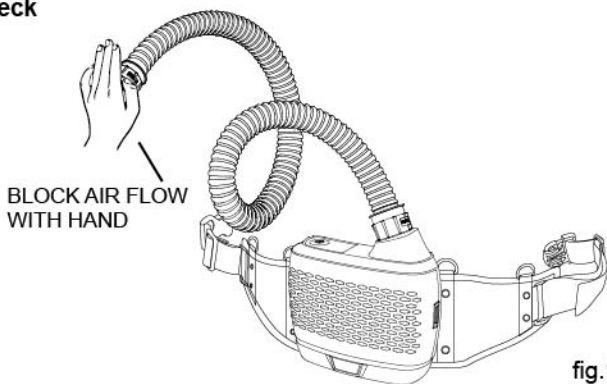

After turning on the product, check the alarm sound warning function by blocking the air outlet as fig.10 shown in the picture above. The warning signal on the panel should flash with a sound and blower vibrate (approximately 15 to 30 seconds after the outlet is blocked). The product is working correctly if the warning functions follow the process above. (Please make sure the filter is equipped and the battery is fully charged before doing this test.)

Airflow rate test

Take airflow test always before using this product.

Make sure all the components are fully assembled before testing.

Connect the end of hose to the bottom of airflow indicator and then start the Button. Keep the Flow Indicator vertical (See fig.11).

If the ball inside the pipe floating above the limited line in low speed mode, it proves normal function.

If the ball cannot float up to limited line, please refer to Trouble-shooting Guide on page11.

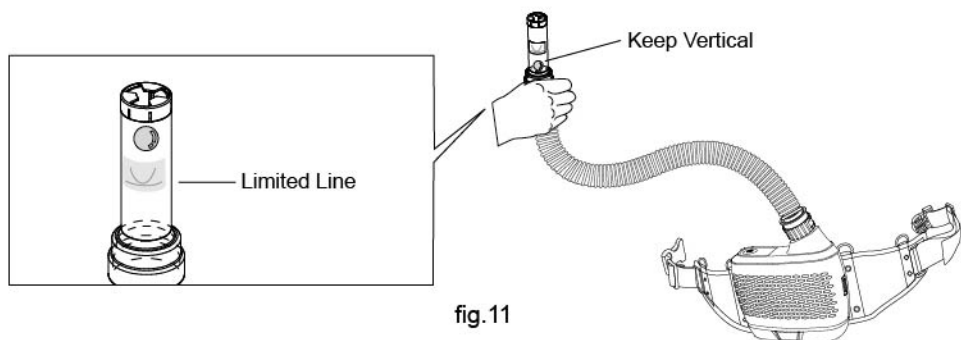

fig.11

MAINTENANCE

The respirator components must be cleaned, inspected and prepared for next use after each use. Use soft cloth dipped in mild soap water for wiping. Be careful for the water NOT to get inside the body.

CLEANING

1. Blower unit and battery pack: Clean the outer surfaces of the PAPR and battery pack with a soft cloth dampened in a solution of water and mild, pH neutral detergent. Be careful for the water NOT to get inside the body. Do not use solvents or abrasive cleaners. Ensure the electrical contacts of the motor/blower and battery pack are dry before assembling well.
2. Breathing tube: Wiping the exterior is insufficient. Clean the outer hose and connection on the breathing tube with the soft cloth dipped in water and detergent solution. Optional breathing tube covers can also be used to facilitate cleaning. Ensure the breathing tube is completely dry before using or storing. They cannot be immersed in liquids for cleaning and must be replaced if wet.
3. Filter: Open the filter cover and inspect all the filters and spark screens. The Particle, gas and pre-filters cannot be cleaned. The spark screen can be cleaned using a clean, soft cloth dipped in a solution of water and a mild pH neutral detergent. Completely dry the spark screen with a clean cloth. Replace the pre-filter and Particle filter if excessively dirty, wet or damaged. Do not attempt to remove contamination using a compressed air line as this will automatically invalidate the warranty. If the spark screen cannot be cleaned or is damaged, replace with a new spark screen.

The face seal can be used to facilitate cleaning after disassembling from the shell, but it must be replaced if it is damaged.

STORAGE

The TP SERIES PAPR system is not intrinsically safe. Keep away from flammable, or explosive atmosphere. Storage should be in a clean, dry, cool place with filter.

Blower storage

Stored at a temperature between 14°F to 131°F (-10°C to 55°C), in a clean environment without direct light.

Battery storage

To help maximize battery service life:

- Disconnect the charger after a full charge has been received.
- Battery should be removed from blower if long time storage.
- Store the battery at 14°F to 113°F (-10°C to 45°C), R.H. <85%, to get maximize battery service life.

TROUBLE-SHOOTING GUIDE

Problems	Causes	Trouble-shooting
No airflow from blower	Blower not ON	Long press ON button.
	Battery no power	Charge the battery.
	Battery not installed properly	Check and reassemble the battery.
	Tube blocked/air leakage	Check and clear the obstruction.
Airflow test failed	The hose may get blocked/air leakage	Check the tube status.
	Dirty filter needs replacement	Replace new filter.
Battery time is too short even fully charged	Battery faulty	Replace new battery.
	Incorrect charging	Fully charge battery.
	Blocked filter	Replace filter.
	Damaged charger	Replace a new charger.
Increased sound level	Filter is getting clogged	Replace filter and pre-filter as required.
Warning indicator ON, blower vibrate and alarm sound sleeping	Tube gets blocked/air leakage	Check if tube/anywhere gets blocked before use.
	Filter assembled without removing the package	Check if the package is removed.
Feeling smell of incoming air	Damaged Filter	Check the filter status and replace new one if needed.
	Hose with leakage problem	Check how the tube assemble as well as status.
	Filter component not complete	Check and equip both filters.

WELDING HELMET OPERATING INSTRUCTION



WARNING

Read & Understand All Instructions Before Using



TP Series 200 powered air purifying face shield has a compact shape and a balanced center of gravity. Used together with PAPR respirator, the overall filtration efficiency is as high as 99.97%. It is convenient, comfortable and easy to adjust, providing users with comprehensive protection for respiratory, eyes and face, head, and hearing (requires noise-cancelling earmuffs).

Please do not raise the visor during usage, failure to follow this instruction to use this product may seriously affects the user's health.



WARNING



- Use of this product for other operations, such as laser welding/cutting, can result in permanent eye damage and loss of vision.
- This product is not suitable for protection against X-rays, Gamma rays, high energy particulate radiation, lasers and masers.
- Pls make sure the protection film be removed before use.
- Inspect the face shield before use to make sure it is fully assembled and well- functioned, to ensure safety.
- Check before use to determine whether this product is suitable for your application.
- Replace the protective visor immediately if pitted, scratched or broken, otherwise it will reduce vision clarity, or reduce impact protection.
- Before using the face shield, ensure that you have read and well understood the instructions. The Warranty Terms don't cover problems such as those caused by: unauthorized modifications; using unauthorized spare parts; abuse; failure to follow the instructions; improper maintenance; repairing.
- It will not provide protection against IR.
- There are only original spare parts (See page 19) to be installed. For information about suitable spare parts pls contact the dealer or manufacturer.
- The duration of use depends on various factors such as use, cleaning storage and maintenance. Frequently inspections and replacement if it is damaged are recommended.
- Materials which may come into contact with the wearer's skin could cause allergic reactions to susceptible individuals.
- Eye-protectors against high speed particles worn over standard ophthalmic spectacles may transmit impacts, thus creating a hazard to the wearer.
- If protection against high speed particles at extremes of temperature is required then the selected eye-protector should be marked with the letter T immediately after the impact letter, i.e. FT, BT or AT. If the impact letter is not followed by the letter T then the eye protector shall only be used against high speed particles at room temperature.
- If the symbol F, B and A are not common to both the ocular and the frame, then it is the lower level which shall be assigned to the complete eye-protector.
- The optical class 3 oculars are not intended for long term use.
- For a face shield to comply with field of use symbol 8, it should be fitted with a filter of scale number 2-1,2 or 3-1,2 and have a minimum thickness of 1,4mm.
- For an eye-protector to comply with field of use symbol 9, both the frame and ocular shall

- be marked with this symbol together with one of the symbol F, B and A.
- The user shall contact the health and safety representative to ensure he is given the proper protection by the personal eyewear during working conditions.
 - Substitute parts, films not included in instruction manual, or spraying or other modifications to face shield will seriously damage the product's protective function and void the warranty, or cause the product's use effect to be inconsistent with protection level and certification.
 - Failure to strictly follow all instructions for use and/or to wear product incorrectly throughout exposure can damage wearer's health, resulting in serious or fatal illness, injury, or permanent disability.
 - Dispose of waste product parts in accordance with local regulations.

Before / after using TP Series 200 face shield. Check the following items.

- If protective visor is soiled, change the visor.
- Make sure there is sufficient ambient light.
- Replace worn or damaged parts immediately.
- Do not use parts other than those produced by the manufacture.
- Headgear must be adjusted to fit properly before use.
- Make sure the face seal is securely and properly attached.
- Make sure the breathing tube securely assembled.
- The face shield should be stored in dry, cool area when not using it for long time.



WARNING



Severe personal injury could occur if the user fails to follow the above mentioned warnings, and/or fails to follow the operating instructions.

COMMON PROBLEMS AND REMEDIES

• Poor vision

- ① Protective visor is soiled (Change visor).
- ② There is insufficient ambient light.
- ③ Check if removing the film on the visor.



WARNING



The user must stop using the face shield immediately if the above-mentioned problems cannot be corrected. Contact the dealer.

INSTRUCTIONS FOR USE

WARNING! Before using the face shield, ensure that you have read and understood the safety instructions.

• ADJUST HEADGEAR

- Step 1 : Adjust the top band to most comfortable length according to wearer's head size (See fig.12a).
- Step 2 : Put the face shield on and adjust the face seal, make sure the face seal fully sealed around the face (See fig.12b).
- Step 3 : Adjust the back headgear knob until the face shield fixed on the head properly (See fig.12c).



fig. 12a



fig. 12b



fig. 12c

• FACE SHIELD HEIGHT ADJUSTMENT

If you feel uncomfortable or unbalanced when wearing face shield, please remove it and adjust front and rear gears of headgear to appropriate position.

Demonstration of the principle (See fig.13)

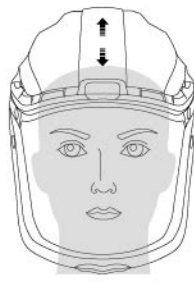

fig.13

Step 1 : Remove complete headgear (See fig.14a).

Step 2 : After adjusted, put it back in face shield (4 points adjustable) (See fig.14b). Make sure the headgear is not twisted.

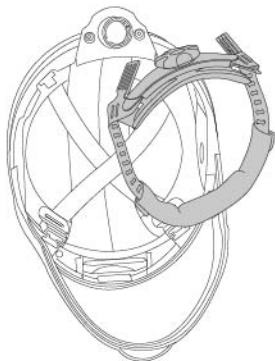

fig.14a

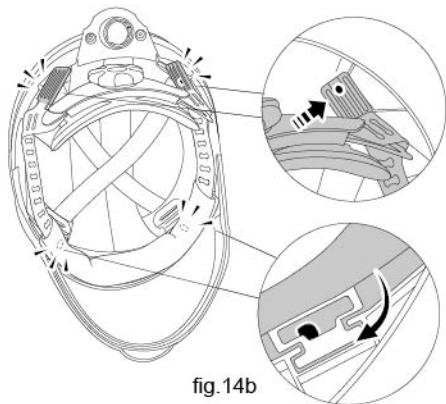

fig.14b

• AIR FLOW DIRECTION ADJUSTMENT

Toggle forehead air flow direction adjustment plate to adjust direction of the airflow in face

shield to ensure comfortable wearing (2 gears adjustable) (See fig.15)

• CONNECT HOSE TO HELMET

Pull the head of hose to connect it to protruding connector of G20-V helmet, and then release the head of hose to complete the fixing (See fig.16).

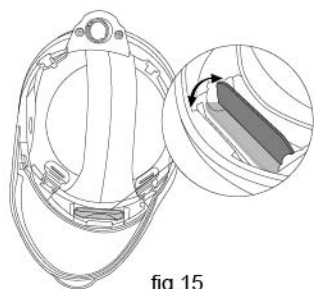

fig.15

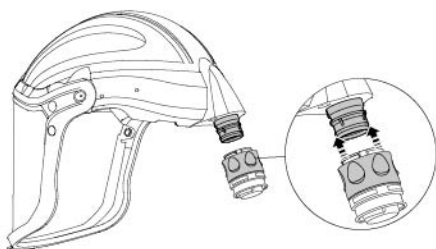

fig.16

MAINTENANCE

• REPLACING PROTECTIVE VISOR

To remove visor: Pull up the latches and remove buckles from both sides (See fig.17a / 17b), keep the parts appropriately. Push the central of visor top edge from internal side, until you hear a "click" to get out the visor (See fig.18a / 18b).

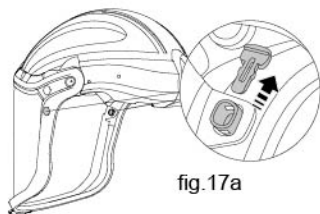

fig.17a

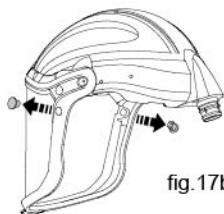

fig.17b

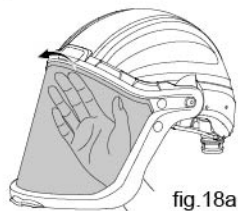

fig.18a



fig.18b

To install visor: Put the one side of the visor into the slot (See fig.19a) and then put the other side of the visor into the slot (See fig.19b / 19c). Press the center of the top edge of the visor inward from the outer side until you hear a "click" sound to fix the visor (See fig.19d). Place the buckles in the position shown and slide down the latches firmly until you hear a "click" sound (See fig.19e).

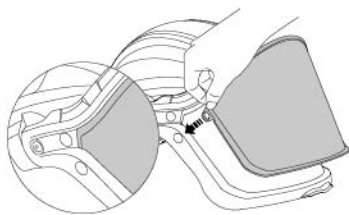

fig.19a



fig.19b

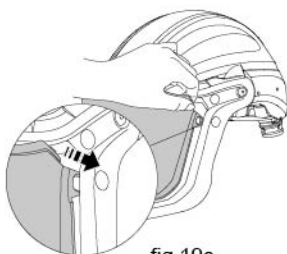

fig.19c

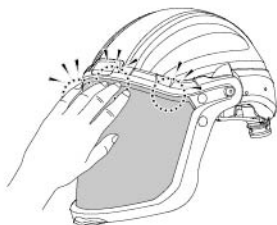

fig.19d

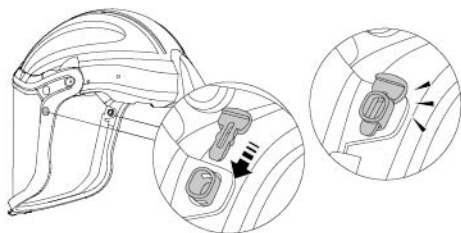

fig.19e

• REPLACING FACE SEAL

Fix the edge groove of the face seal to the edge of the outside frame of the face shield (See fig.20a), and press to the arrow direction to complete the installation (See fig.20b), and hang the inner and outer elastic bands on both sides to the "T" hook to fix (See fig.20c).

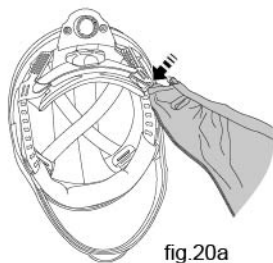

fig.20a

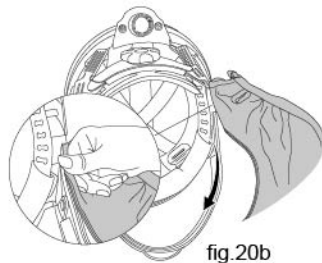

fig.20b

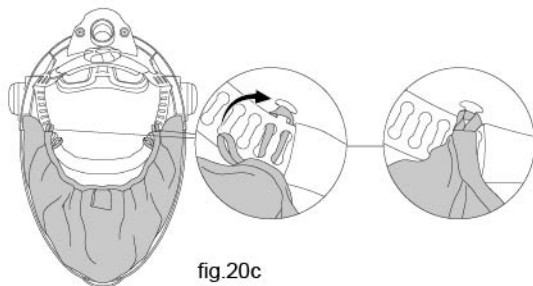

fig.20c

• SWEATBAND AND BACK PAD REPLACEMENT

Remove headgear from face shield (See fig.21a / 21b).

Replace sweatband and back pad with new one, and then put complete headgear back into face shield (See fig.21c)

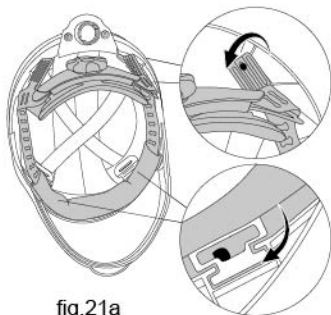

fig.21a



fig.21b



fig.21c

Remove soft band from headgear and replace with a new webbing (See fig.22).

Rotate buckles on both sides of headgear, remove old chin strap, and after installing new chin strap, rotate buckles to complete the fixing (See fig.23).



fig.22

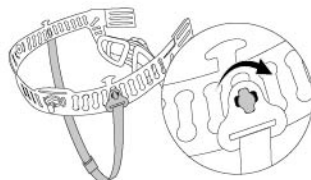

fig.23

• REPLACING VISOR FRAME ASSEMBLY

Push out the button from inside of the visor (See fig.24a), disassemble two buttons from both sides (See fig.24b), remove the visor frame assembly and replace the new one (See fig.24c).

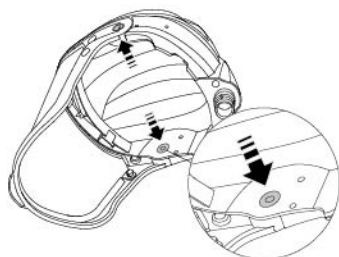

fig.24a



fig.24b



fig.24c

• **CLEANING AND DISINFECTION**

Clean the face shield by wiping with a soft cloth. Clean the visor surfaces regularly. Do not use strong cleaning solutions. Clean it with methylated spirit and a clean cloth and wipe dry with a lint-free cloth.

TECHNICAL SPECIFICATIONS

Face Shield Model No.:	TP Series 200
Viewing Area:	426 cm ² (66 sq. in)
Operating Temp.:	-10°C ~ 55°C (14°F ~ 131°F)
Storing Temp.:	-30°C ~ 50°C (-22°F ~ 122°F)
Application Industry:	Painting / Metal processing / Other applications with hot particles

PARTS LIST & ASSEMBLY

General Assembly

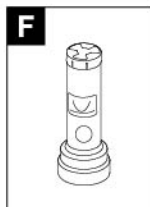
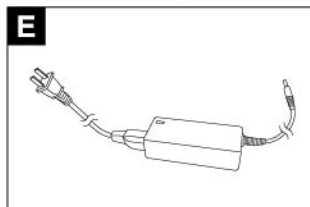
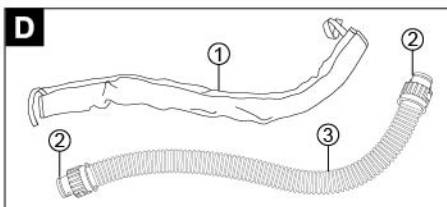
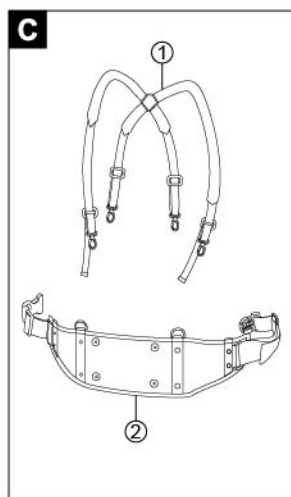
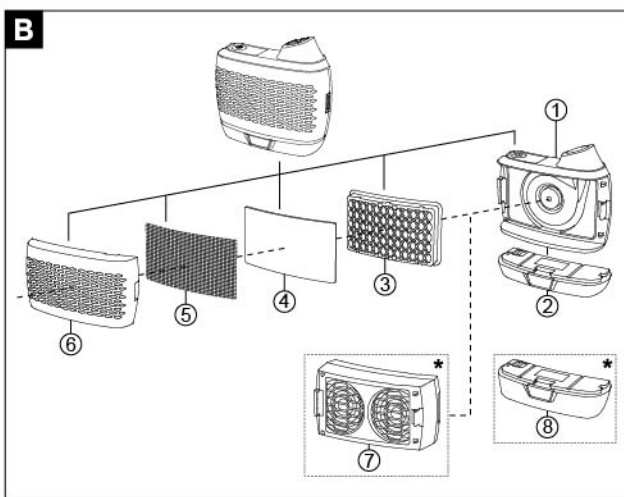
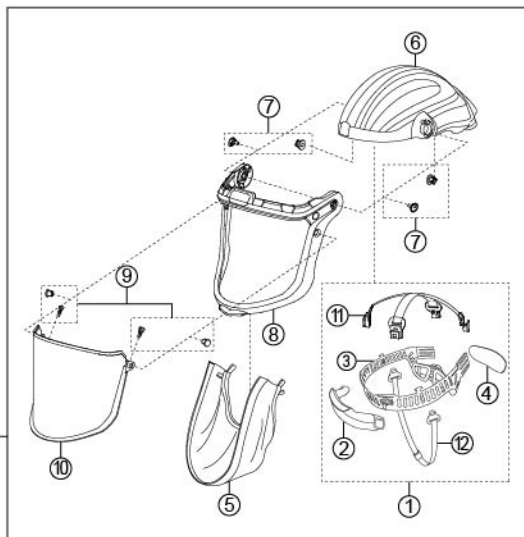
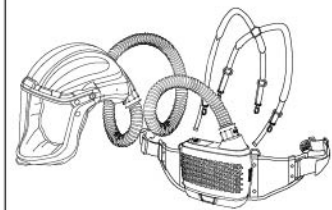

The part with * means it is not included in the product, which need to be purchased seperately.

PARTS LIST & ASSEMBLY

ITEM	PART NO.	DESCRIPTION
A. QUANTUM Helmet with Air Duct Assembly		
A-1	RP220-0000-005-ONE	TP 200 Series Headgear
A-2	AC529-0000-005-ONE	TP Series Front Sweatband
A-3	AC549-0000-005-ONE	TP Series Helmet Front Headgear Strap
A-4	AC433-000-005-000	TP Series Rear Sweatband
A-5	AC528-0000-005-ONE	TP Series Face Seal
A-6	AC542-0000-005-ONE	TP 200 Series Hard Hat Replacement
A-7	AC532-0000-005-ONE	TP Series Hard Hat Buttons
A-8	AC533-0000-005-ONE	TP Series Visor Frame Assembly
A-9	AC534-0000-005-ONE	TP Series Visor Frame Buttons
A-10	EP308-0000-041-ONE	TP Series Replacement Visor (clear anti-scratch)
A-11	AC544-0000-005-ONE	TP 200 Series Nylon Head Suspension
A-12	AC543-0000-005-ONE	TP Series Chin Strap
B. Blower Unit		
B-1	RP153-000-005-000	Body
B-2	AC420-000-005-000	Fast-charging standard battery
B-3	RP154-000-033-000	Particle filter (P3 filter)
B-4	RP155-000-033-000	Pre-filter
B-5	RP156-000-037-000	Spark screen
B-6	AC421-000-005-000	Filter cover
B-7*	RP160-000-005-000	Gas filter
B-8*	AC436-000-005-000	Fast-charging extended battery
C. Wears		
C-1	AC422-000-005-000	Shoulder strap
C-2	AC423-000-005-000	Belt cushion (Including screws & washers)
D. Hose		
D-1	AC424-000-005-000	Hose cover
D-2	AC425-000-005-000	O-ring
D-3	AC426-000-005-000	Hose (Including O-ring)
E. Battery Charger		
E	AC427-000-005-000	Fast-charging battery charger
F. Airflow Indicator		
F	AC428-000-005-000	Airflow indicator

The part with * means it is not included in the product, which need to be purchased seperately.

WARRANTY

Universal's only obligation shall be repair, replace or refund the purchase price of such parts or products material and fabrication defects free of charge within the warranty period.

This warranty does not cover to cause by improper handling abuse or application other than recommended in the user instruction.

If you come across any problem during warranty period, contact your distributor, send the defective parts together with the completed defect problem if necessary.

For future reference, please complete the owner's record below:

Serial Number:

Purchase Date:



EN12941:1998 +A2:2008, Class TH3 P R SL.

DIN EN175:1997

DIN EN379:2009-07

DIN EN166:2001

(EU) 2016/425

UKCA-B-210967

Approved body No: 0194

UNIVERSAL PPE & WELDING SUPPLIES LTD

Aqua House, Buttress Way, Smethwick, West Midlands,

England, B66 3DL

info@universalppe.co.uk

Tel: +44 (0) 121 555 7167